

MC 475 M25

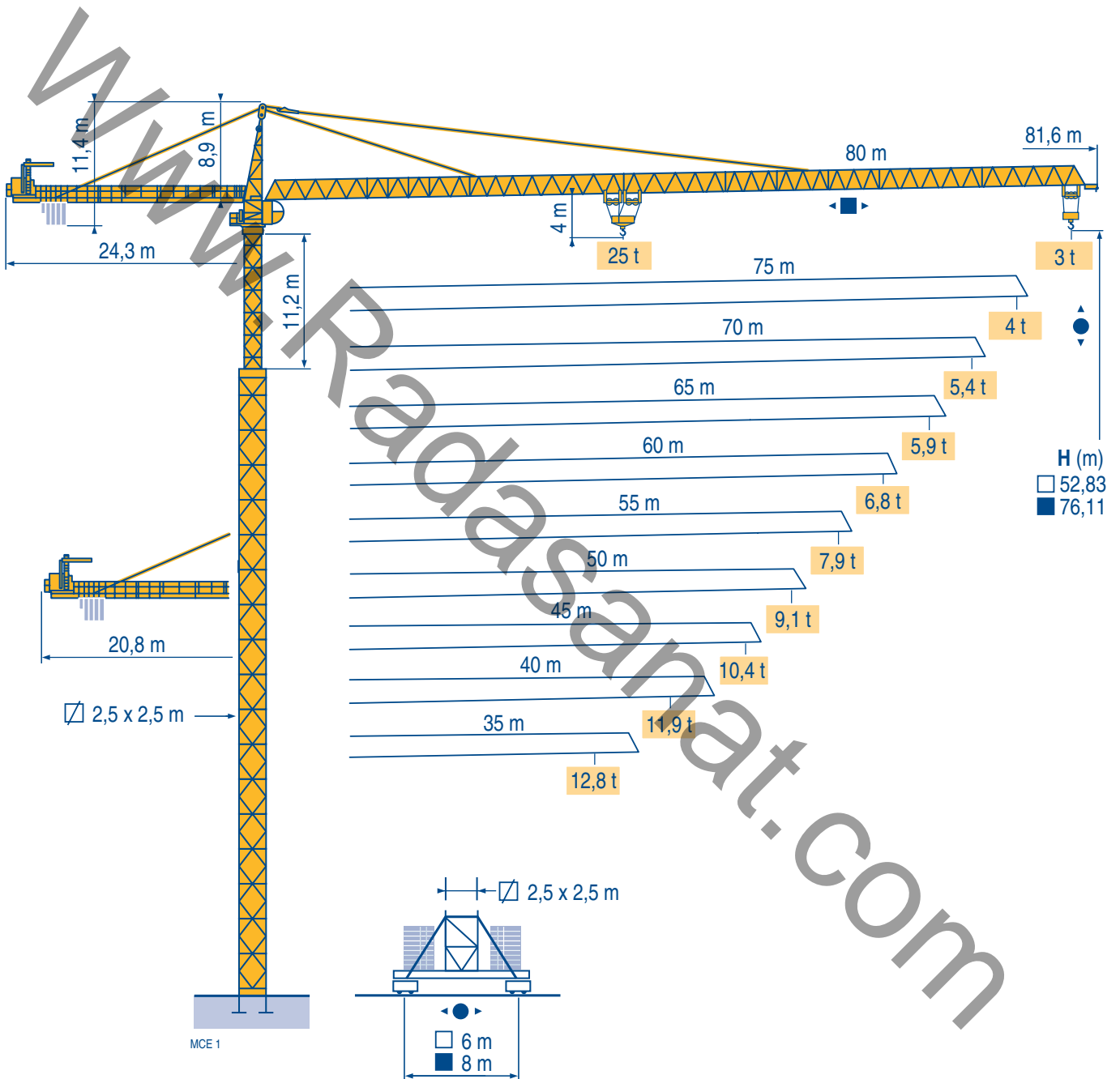

Radasanat.com
(0098)-9121834995

Masts / Reactions

□ 2,5 m

MCE 1

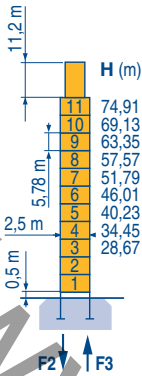

P 80 A	
F2	● 196 t
	■ 248 t
F3	● 115 t
	■ 179 t
	▲ 107 t

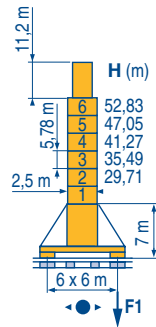

X 80 A	
F1	● 115 t
	■ 100 t
	▲ 103 t

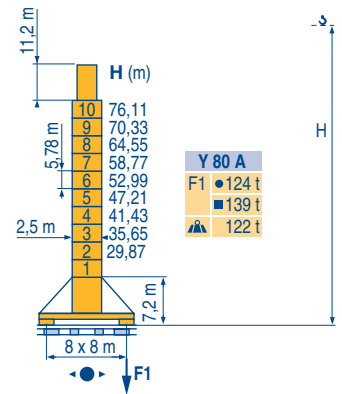

Y 80 A	
F1	● 124 t
	■ 139 t
	▲ 122 t

Anchorage

MCE 1

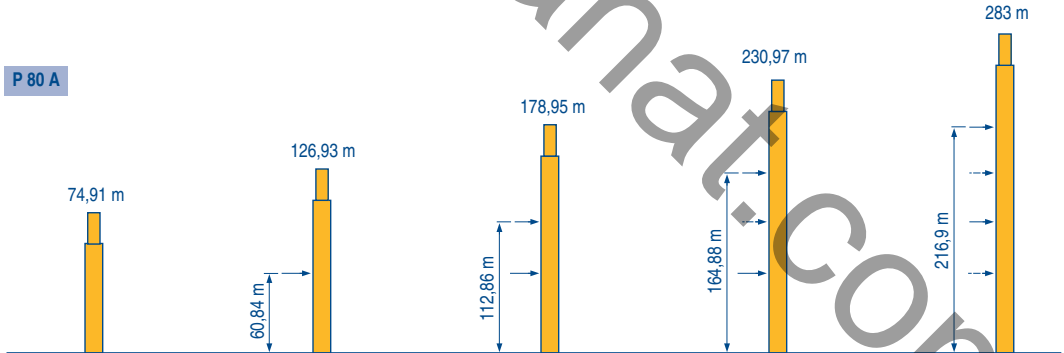

Radasanat.com

(0098)-9121834995



MC 475 M25

GB

- Reactions in service
- Reactions out of service
- ▲ Without load, ballast (or transport axles), with maximum jib and maximum height.

Load diagrams

MCE 1



80 m	3,1 ▶	14,3	15	17	20	22	25	25,2	27,2	30	32	35	40	45	50	55	60	65	70	75	80	m
		25	23,6	20,3	16,7	14,8	12,6	12,5	12,5	11,1	10,3	9,3	7,9	6,8	5,9	5,2	4,6	4,2	3,7	3,4	3	t
75 m	3,1 ▶	15,6	17	20	22	25	27	27,7	29,9	32	35	40	45	50	55	60	65	70	75		m	
		25	22,6	18,6	16,6	14,2	12,9	12,5	12,5	11,6	10,4	8,9	7,7	6,8	6	5,3	4,8	4,3	4		t	
70 m	3,1 ▶	18	20	22	25	27	30	32,3	34,8	35	40	45	50	55	60	65	70				m	
		25	22,2	19,8	17,1	15,6	13,7	12,5	12,5	12,4	10,7	9,3	8,2	7,3	6,6	5,9	5,4				t	
65 m	3,1 ▶	18,1	20	22	25	27	30	32,4	34,9	35	40	45	50	55	60	65					m	
		25	22,2	19,9	17,1	15,6	13,7	12,5	12,5	12,5	10,7	9,3	8,2	7,3	6,6	5,9					t	
60 m	3,1 ▶	18,7	20	22	25	27	30	32	33,4	36,1	40	45	50	55	60						m	
		25	23,1	20,7	17,8	16,2	14,3	13,2	12,5	12,5	11,1	9,7	8,5	7,6	6,8						t	
55 m	3,1 ▶	19,3	20	22	25	27	30	32	34,6	37,4	40	45	50	55							m	
		25	24	21,5	18,5	16,9	14,9	13,8	12,5	12,5	11,6	10,1	8,9	7,9							t	
50 m	3,1 ▶	19,6	20	22	25	27	30	32	35,1	37,9	40	45	50								m	
		25	24,4	21,8	18,8	17,2	15,1	14	12,5	12,5	11,7	10,2	9,1								t	
45 m	3,1 ▶	19,7	20	22	25	27	30	32	35,4	38,2	40	45									m	
		25	24,6	22,1	19	17,3	15,3	14,1	12,5	12,5	11,9	10,4									t	
40 m	3,1 ▶	19,9	20	22	25	27	30	32	35,6	38,4	40										m	
		25	24,8	22,2	19,1	17,5	15,4	14,3	12,5	12,5	11,9										t	
35 m	3,1 ▶	20	22	25	27	30	32	35													m	
		25	22,4	19,3	17,6	15,5	14,3	12,8													t	

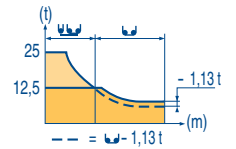

Counter-jib ballast

MCE 1

4 000 kg - 6 000 kg		
150 LCC		
Crane	Length (m)	Weight (kg)
80 m	24,3 m	30 000
75 m	24,3 m	28 000
70 m	24,3 m	28 000
65 m	24,3 m	26 000
60 m	24,3 m	22 000
55 m	24,3 m	20 000
50 m	20,8 m	26 000
45 m	20,8 m	22 000
40 m	20,8 m	20 000
35 m	20,8 m	16 000

Base ballast

MCE 1

Crane	H (m)	H (m)				
		52,83	47,05	41,27	35,49	29,71
2,50 m X 80 A	(t)	96	96	96	96	96

Crane	H (m)	H (m)								
		76,11	70,33	64,55	58,77	52,99	47,21	41,43	35,65	29,87
2,50 m Y 80 A	(t)	96	84	60	60	60	60	60	60	60

MC 475 M25





POTAIN

Mechanisms

MCE 1

MC 475 M25 - 50 Hz													ch - PS hp	kW		
▲ ▼	150 LCC 63	m/min	46 → 56 → 70 → 92 → 110					23 → 28 → 35 → 46 → 55					150	110	461 m	
		t	12,5	9	6	3	1,56	25	18	12	6	3,12				
⊙	RVF 183 Optima +	tr/min U/min - rpm	0 → 0,8											3 x 12	3 x 9	
◀ ▶	10 DVF 10	m/min	0 → 64 (25 t) - 0 → 100 (12,5 t) - 0 → 110 (6,25 t)											10	7,4	
⊙ ⊙	X 80 A Y 80 A	RT 664 A2B - 2V	16 - 32											6 x 7	6 x 5,2	
CEI 38		IEC 38	kVA										2000 / 14			
400 V (+6% -10%)		150 LCC : 185 kVA														

MC 475 M25 - 60 Hz													ch - PS hp	kW		
▲ ▼	150 LCC 63	m/min	46 → 56 → 70 → 92 → 110					23 → 28 → 35 → 46 → 55					150	110	461 m	
		t	12,5	9	6	3	1,56	25	18	12	6	3,12				
⊙	RVF 183 Optima +	tr/min U/min - rpm	0 → 0,8											3 x 12	3 x 9	
◀ ▶	10 DVF 10	m/min	0 → 64 (25 t) - 0 → 100 (12,5 t) - 0 → 110 (6,25 t)											10	7,4	
⊙ ⊙	X 80 A Y 80 A	RT 664 A2B - 2V	19 - 38											6 x 8,4	6 x 6,2	
CEI 38		IEC 38	kVA										2000 / 14			
480 V (+6% -10%)		150 LCC : 215 kVA														

-  **GB** Hoisting
-  Trolleying
-  Slewing
-  Travelling
-  In compliance with the EEC Instructions on noise level

 This commercial document is not legally binding.
For any technical information, please refer to the corresponding instructions.

Radasanat.com
(0098)-9121834995



Americas
Tel : +1 920 683 6322
Tel : +1 717 597 8121

Europe - Middle East - Africa
Tel : +(33) 4 72 81 50 00
Tel : +(44) 191 565 6281

Asia - Pacific
Tel : +(65) 6861 7133
Fax : +(65) 6862 4142

www.manitowoccrane.com

Manitowoc Crane Group

Manitowoc Crane Group Asia Pte Ltd
Manitowoc Crane Group
26 Benoi Road
Singapore 629898
Tel: 65-6861 7133
Fax: (Admin/ Sales) : 65-6862 4040
Fax: (Service/ Parts) : 65-6862 4142
www.manitowoccrane.com

MC 475 M25
Réf. 2004 45 MCE 1
Copyright.Reproduction interdite © POTAIN 2004

Réalisation Sedoc