

Potain MC 125

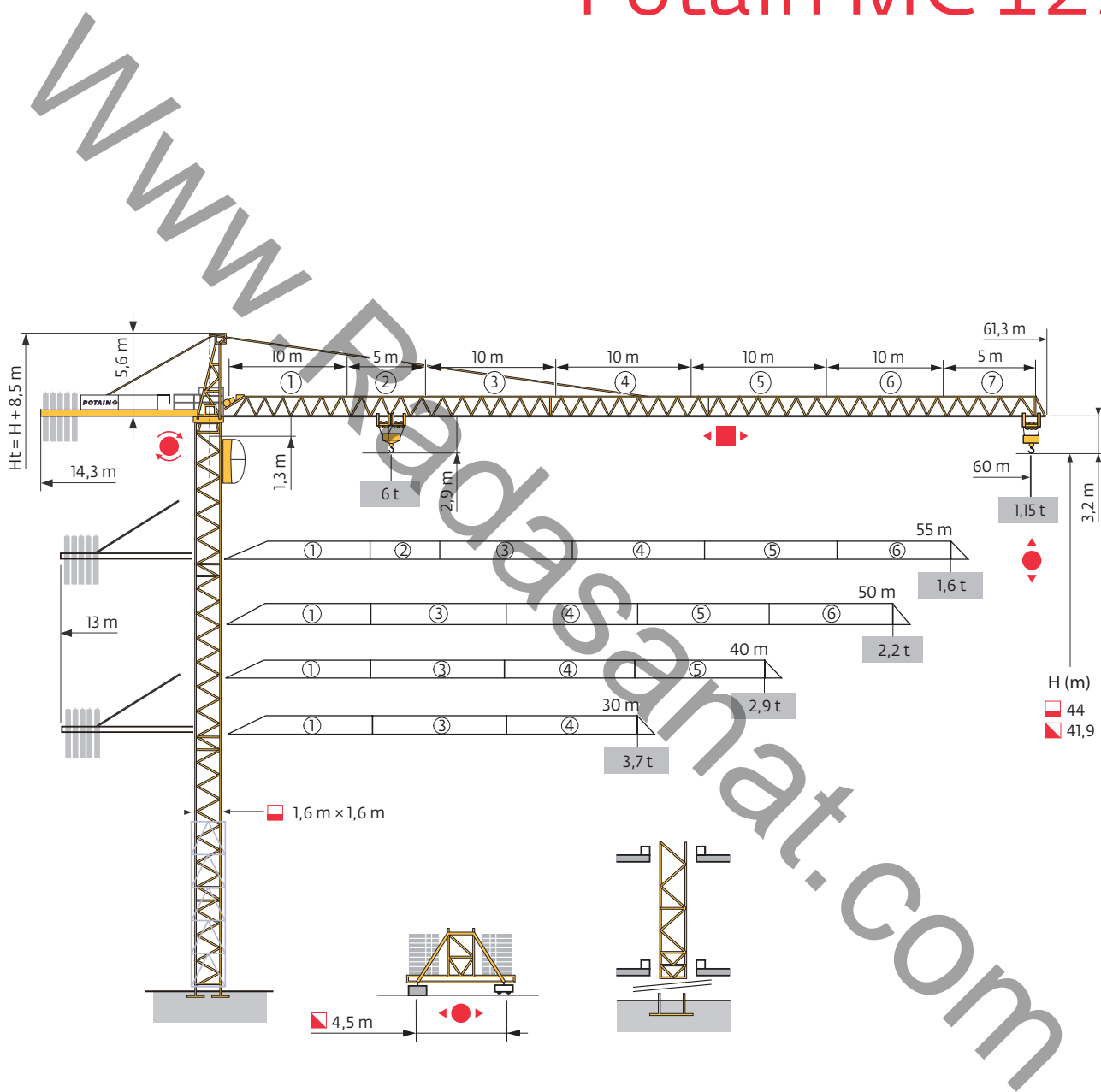

Radasanat.com

(0098)-9121834995

Mât - Réactions / Mast - Reaktionskräfte / Mast - Reactions / Mástil - Reacciones / Torre - Reazioni
 Tramo - Reações / Реакция опор мачты

□ 1,6 m

▲▲▲ 30 m → 60 m

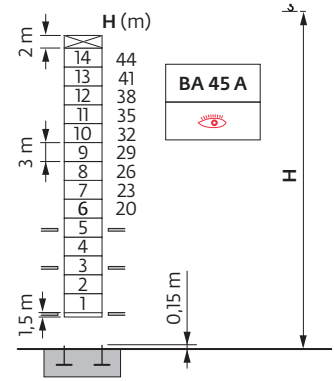
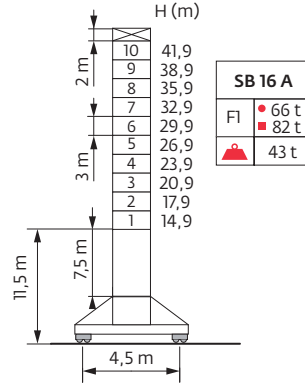
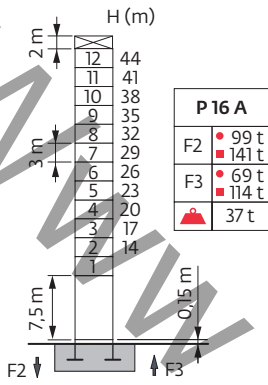

Télescopage sur dalles / Kletterkrane im Gebäude / Climbing Crane / Telescopage grua trepadora / Gru in cavedio
 Telescopagem sobre lajes / Кран, ползущий внутри здания

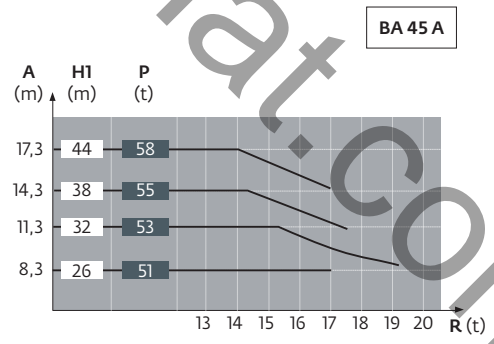
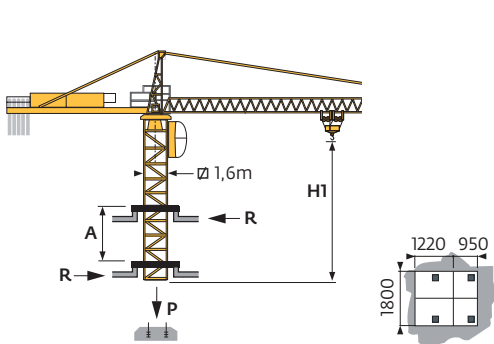

P 16 A

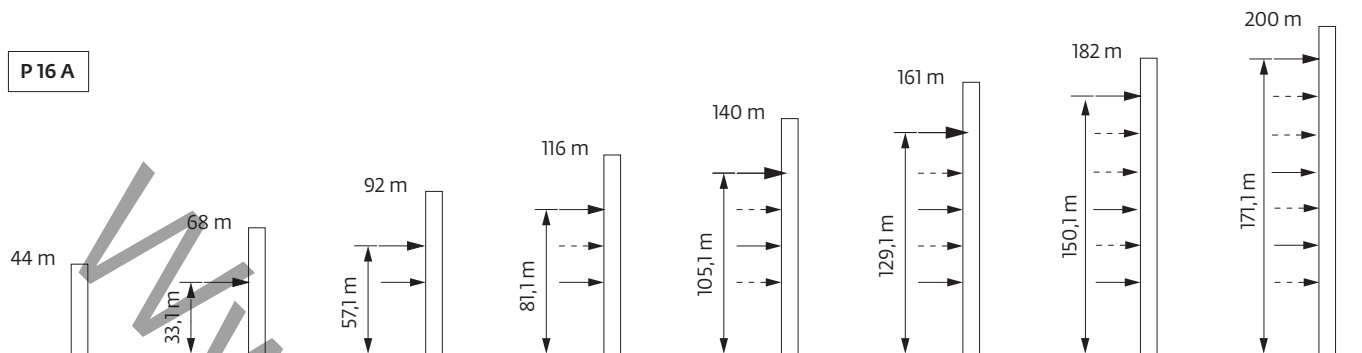

H > 200m



Courbes de charges / Lastkurven / Load curves / Curvas de cargas / Curve di carico
 Curvas de carga / Кривые нагрузок



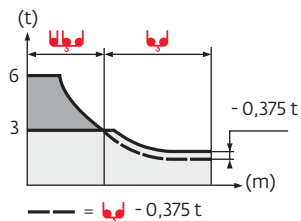

| | | | | | | | | | | | | | | | | | | | | | | | | |
|------|-----|---|------|-----|-----|-----|-----|-----|------|------|------|------|------|------|------|-----|------|-----|------|------|-----|------|------|---|
| 60 m | 3,1 | ▶ | 14,7 | 17 | 19 | 20 | 21 | 24 | 25,6 | 28,2 | 33 | 35 | 38 | 39 | 40 | 43 | 46 | 49 | 50 | 53 | 55 | 57 | 60 | m |
| ▲▼▲▼ | | | 6,0 | 5,0 | 4,4 | 4,1 | 3,9 | 3,3 | 3,0 | 3,0 | 2,5 | 2,3 | 2,1 | 2,05 | 1,95 | 1,8 | 1,65 | 1,5 | 1,45 | 1,35 | 1,3 | 1,25 | 1,15 | t |
| 55 m | 3,1 | ▶ | 17,1 | 19 | 20 | 21 | 24 | 27 | 29,9 | 33 | 35 | 38 | 39 | 40 | 43 | 46 | 49 | 50 | 53 | 55 | | | | m |
| ▲▼▲▼ | | | 6,0 | 5,3 | 5,0 | 4,7 | 4,0 | 3,4 | 3,0 | 3,0 | 2,8 | 2,55 | 2,45 | 2,4 | 2,2 | 2,0 | 1,85 | 1,8 | 1,7 | 1,6 | | | | t |
| 50 m | 3,1 | ▶ | 20 | 21 | 24 | 27 | 30 | 33 | 34,9 | 38,6 | 39 | 40 | 43 | 46 | 49 | 50 | | | | | | | | m |
| ▲▼▲▼ | | | 6 | 5,6 | 4,8 | 4,2 | 3,6 | 3,2 | 3,0 | 3,0 | 2,95 | 2,9 | 2,65 | 2,45 | 2,25 | 2,2 | | | | | | | | t |
| 40 m | 3,1 | ▶ | 20,1 | 21 | 24 | 27 | 30 | 33 | 35 | 35,1 | 38,9 | 40 | | | | | | | | | | | | m |
| ▲▼▲▼ | | | 6,0 | 5,7 | 4,8 | 4,2 | 3,7 | 3,3 | 3,0 | 3,0 | 2,9 | | | | | | | | | | | | | t |
| 30 m | 3,1 | ▶ | 20,2 | 21 | 24 | 27 | 30 | | | | | | | | | | | | | | | | | m |
| ▲▼▲▼ | | | 6,0 | 5,7 | 4,9 | 4,2 | 3,7 | | | | | | | | | | | | | | | | | t |





Lest de base / Grundballast / Base ballast / Lastre de base / Zavorra di base
 Lastro da base / Базовый Балласт

| | | | | | | | | | | | | |
|---|---|--|------|------|------|------|------|------|------|------|------|------|
|  1,6 m | SB 16 A  | H (m)  (t) | 41,9 | 38,9 | 35,9 | 32,9 | 29,9 | 26,9 | 23,9 | 20,9 | 17,9 | 14,9 |
| | | | 78 | 66 | 66 | 60 | 60 | 60 | 54 | 54 | 54 | 54 |

Lest de contre-flèche / Gegenauslegerballast / Counter-jib ballast / Lastre de contra-flecha / Zavorra di controbraccio
 Lastro da contra lança / Противовес стрелы

|  | 3450 kg | 2250 kg |  (kg) |
|---|---------|---------|--|
| 60 m | 5 | 0 | 17 250 |
| 55 m | - | - | - |
| 50 m | 4 | 1 | 16 050 |
| 40 m | 4 | 0 | 13 800 |
| 30 m | 2 | 2 | 11 400 |

|  | 3700 kg | 2250 kg |  (kg) |
|---|---------|---------|--|
| 60 m | 4 | 1 | 17 050 |
| 55 m | 5 | 0 | 18 500 |
| 50 m | 4 | 1 | 17 050 |
| 40 m | 2 | 3 | 14 150 |
| 30 m | 2 | 2 | 11 900 |

CCB - 3700 kg

CD - 3450 kg

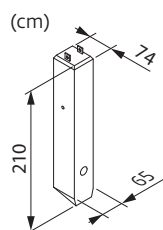
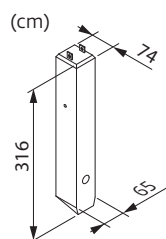
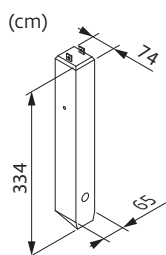

CE - 2250 kg



Encombremet et poids / Abmessungen und Gewicht / Dimensions and weight / Dimensiones y peso / Ingombro e peso
 dimensões e pesos / габаритные размеры и вес

Partie tournante / Drehender Kranteil / Slewing crane part / Parte giratoria
 Parte rotante / Parte rotativa / Поворотная часть : 60 m - 33 PC 15 / 40 LVF 15

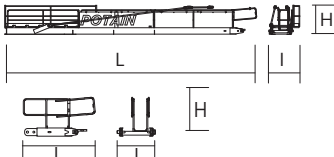
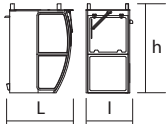
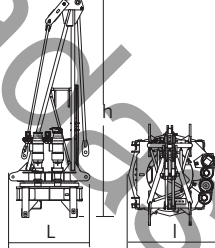
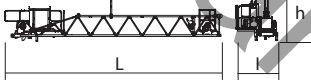
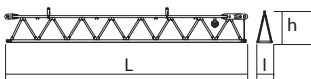
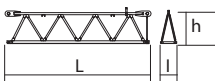
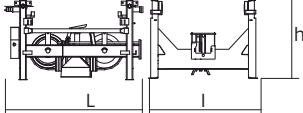
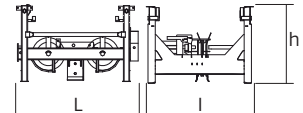
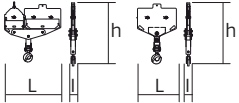

| Partie tournante / Drehender Kranteil / Slewing crane part Parte giratoria / Parte rotante / Parte rotativa Поворотная часть | L (m) | l (m) | h (m) | kg (+/-5%) |
|---|-------|-------|-------|---------------|
| Contre-flèche / Gegenausleger Counter-jib / Contra-flecha Controbraccio / Contra-lança Контр-стрела  | 11,94 | 1,46 | 1,40 | 2215 |
| cabine / Kabine cab / cabina cabina / cabina кабина  | 1,675 | 1,175 | 2,305 | 385 |
| Porte-flèche / Auslegerträger Cathead / Porta-flecha Cuspide / Suporte de lança Оголовок  | 2,365 | 1,920 | 6,965 | 4680 |
| Élément de flèche / Auslegerelement Jib section / Elemento de flecha Elemento di braccio / Elemento de lança Секция стрелы  | 10,12 | 1,30 | 1,16 | 3200 |
| Élément de flèche / Auslegerelement Jib section / Elemento de flecha Elemento di braccio / Elemento de lança Секция стрелы  | 10,20 | 1,10 | 1,30 | 1125 |
| Élément de flèche / Auslegerelement Jib section / Elemento de flecha Elemento di braccio / Elemento de lança Секция стрелы  | 5,20 | 1,10 | 1,30 | 620 |
| Chariot / Laufkatze Trolley / Carrello Carro / Carro-distribuidor Тележка  | 1,60 | 1,40 | 1,00 | 269 |
| Chariot / Laufkatze Trolley / Carrello Carro / Carro-distribuidor Тележка  | 1,50 | 1,40 | 1,00 | 289 |
| Moufle / Hubflasche Pulley block / Aparejo Bozzello / Cadernal Полиспаст  | 1,30 | 0,30 | 1,55 | 330 |
| Moufle / Hubflasche Pulley block / Aparejo Bozzello / Cadernal Полиспаст  | 0,78 | 0,30 | 1,55 | 114 |

| Equipement de télescage / Teleskopierausrüstung / Telescoping equipment Equipo de telescopaje / Equipaggiamento di telescopaggio / Equipamento de telescopagem Оборудование для телескопирования | | L (m) | l (m) | h (m) | kg (+/- 5%) | |
|---|---|--------------------------------------|------------------------------|------------------------------|------------------------------|------------------------------|
| Cage de télescage / Teleskopwagen Telescopic cage / Jaula de telescopaje Gabbia di telescopaggio / Gaiola de telescopagem для телескопирования крана |  | □1,6 m | 6,80 | 3,65 | 3,90 | 3430 |
| Mâtire / Mastwerk / Masts Mástil / Torre / Coluna Мачты | | | | | | |
| S 46 J |  | □1,6 m | 7,80 | 1,80 | 1,70 | 2520 |
| S 44 A1 L 44 A1 S 46 A1 L 46 A1 |  | □1,6 m □1,6 m □1,6 m □1,6 m | 3,50 3,50 3,50 3,50 | 1,80 1,80 1,80 1,80 | 1,70 1,70 1,70 1,70 | 1020 1080 1199 1224 |
| Bases / Kranbasen / Crane bases Bases / Basi / Bases Фундамент под кран | | | | | | |
| Pieds de scellement / VerankerungsfüÙe Fixing angles / Pie de empotramiento Montante da annegare / Angulos fixadores анкера |  | P 16 A | 1,135 | 0,490 | 0,490 | 185 |
| |  | R 16 A | 0,685 | 0,500 | 0,500 | 145 |
| Mât-châssis / Grundmasteinheit Basic mast unit / Tramo-chassis Elemento base / Tramo-chassis Мачта для крепления к шасси |  | | 3,61 | 2,065 | 1,96 | 2750 |
| Haubans / Mastabstützungen Struts / Tornapuntas Puntoni / Escoras Растяжка |  | | 3,180 | 0,250 | 0,240 | 200 |
| Sommier / Unterwagenhälfte Half-bearer / Testero Testata / Estrutura base Траверса |  | | 5,080 | 1,785 | 0,605 | 1100 |

| 400 V - 50 Hz | | | | | | | | | | | | | hp | kW | | |
|---------------|----------------|--------|--------------|----|-----|------|-----|---|---|----|-----|-------|---------|----|-------|-------|
| | 33 PC 15 (GH) | m/min | 10 | 40 | 80 | | | | | | 5 | 20 | 40 | 33 | 24 | 400 m |
| | | t | 3 | 3 | 1,5 | | | | | | 6 | 6 | 3 | | | |
| | 40 LVF 15 (GH) | m/min | 5 | 14 | 42 | 64 | 85 | 3 | 7 | 21 | 32 | 42,5 | 40 | 30 | 400 m | |
| | | t | 3 | 3 | 3 | 2,25 | 1,5 | 6 | 6 | 6 | 4,5 | 3 | | | | |
| | 4 D3 V3 | m/min | 15 → 30 → 58 | | | | | | | | | 4 | 3 | | | |
| | RCV 145 | tr/min | 0 → 0,8 | | | | | | | | | 2 x 6 | 2 x 4,4 | | | |
| | RT 324 C1 | m/min | 12,5 → 25 | | | | | | | | | 2 x 7 | 2 x 5,2 | | | |

| | |
|-------------------------|-----------------------------------|
| IEC 60204-32 | |
| 400 V (+10% -10%) 50 Hz | 33 PC : 50 KVA 40 LVF : 50 KVA |

| 480 V - 60 Hz | | | | | | | | | | | | | hp | kW | | |
|---------------|----------------|--------|----------------|----|-----|------|-----|---|---|----|-----|---------|----------|------|-------|-------|
| | 33 PC 15 (GH) | m/min | 12 | 48 | 96 | | | | | | 6 | 24 | 48 | 39,6 | 28,8 | 400 m |
| | | t | 3 | 3 | 1,5 | | | | | | 6 | 6 | 3 | | | |
| | 40 LVF 15 (GH) | m/min | 5 | 14 | 42 | 64 | 85 | 3 | 7 | 21 | 32 | 42,5 | 40 | 30 | 400 m | |
| | | t | 3 | 3 | 3 | 2,25 | 1,5 | 6 | 6 | 6 | 4,5 | 3 | | | | |
| | 4 D3 V3 | m/min | 18 → 36 → 69,6 | | | | | | | | | 4,8 | 3,6 | | | |
| | RCV 145 | tr/min | 0 → 0,96 | | | | | | | | | 2 x 7,2 | 2 x 5,28 | | | |
| | RT 324 C1 | m/min | 15 → 30 | | | | | | | | | 2 x 8,4 | 2 x 6,24 | | | |

| | |
|------------------------|-----------------------------------|
| IEC 60204-32 | |
| 480 V (+6% -10%) 60 Hz | 33 PC : 60 KVA 40 LVF : 50 KVA |

www.Radasanat.com

| | FR | DE | EN | ES | IT | PT | RU |
|--|--|--|---|---|---|--|---|
| | Appel de flèche | Auslegerüberhöhung | Jib elevation | Elevación de la flecha | Inclinazione braccio | Desvio da lança | подъем стрелы |
| | Réactions en service | Reaktionskräfte in Betrieb | Reactions in service | Reacciones en servicio | Reazioni in servizio | Reacções em serviço | Реакция при работе |
| | Réactions hors service | Reaktionskräfte außer Betrieb | Reactions out of service | Reacciones fuera de servicio | Reazioni fuori servizio | Reacções fora de serviço | Реакция в покое |
| | A vide sans lest avec flèche et hauteur maximum | Gewicht ohne Last, ohne Ballast, mit Ausleger und max. Höhe | Weight without load, without ballast, with jib and max. height | Peso en vacío sin lastre, con flecha y altura máxima | Peso a vuoto, senza zavorra, con braccio e altezza massimi | Peso em vazio sem lastro com lança e altura máxima. | Вес пустого, без балласта, со стрелой, максимальной высоты. |
| | Poids total du lest | Ballast-Gesamtgewicht | Total ballast weight | Peso total del lastre | Peso totale della zavorra | Peso total do lastro | Общий вес балласта |
| | Camion 13.4 m | Lkw 13.4 m | Lorry 13.4 m | Camión 13.4 m | Camion 13.4 m | Camião 13.4 m | Ррузовой автомобиль 13.4 м |
| | Conteneur High Cube 40" | Container High Cube 40" | Container High Cube 40" | Contenedor High cube 40" | Container High Cube 40" | Contentor 40" | Контейнер повышенной вместимости длиной 40" |
| | Cadre d'ancrage serré | Fester Verankerungsrahmen | Tightened anchorage frame | Marco de anclaje de apriete | Quadro di ancoraggio stretto | Quadro de amarração apertado | Прикрепленная анкерная рама |
| | Cadre d'ancrage desserré | Looser Verankerungsrahmen | Loosened anchorage frame | Marco de anclaje de desapriete | Quadro di ancoraggio allentato | Quadro de amarração solto | Отсоединенная анкерная рама |
| | Levage | Heben | Hoisting | Elevación | Sollevamento | Elevação | Подъем |
| | Distribution | Katzfahren | Trolleying | Distribución | Distribuzione | Distribuição | Перемещение по стреле |
| | Orientation | Schwenken | Slewing | Orientación | Rotazione | Rotação | Поворот |
| | Translation | Kranfahren | Travelling | Traslación | Traslazione | Translação | Перемещение крана |
| | Puissance nominale | Nennleistung | Rated power | Potencia nominal | Potenza nominale | Potência nominal | Номинальная мощность |
| | Voir télescopage sur dalles | Siehe Kletterkrane im Gebäude | See climbing crane | Vea grua trepadora | Consultare gru in cavedio | Ver telescopagem sobre lages | См. кран, ползущий внутри здания |
| | Nous consulter | Auf Anfrage | Consult us | Consultarnos | Consultateci | Consultar-nos | Проконсультируйтесь у нас |
| | Document commercial non contractuel. Pour toute information technique se référer à la notice correspondante. | Unverbindliches Vertriebsdokument. Für technische Informationen, siehe die entsprechenden Anweisungen. | This commercial document is not legally binding. For any technical information, please refer to the corresponding instructions. | Documento comercial no contractual. Para cualquier información técnica, ver la noticia correspondiente. | Documento commerciale non vincolante, per tutte le informazioni tecniche fare riferimento al catalogo istruzioni. | Documento comercial não contratual. Para qualquer informação técnica complementar consultar as respectivas instruções. | Этот коммерческий документ не является юридически обязательным. Для получения технической информации, см. соответствующие инструкции. |

Radasanat.com
(0098)-9121834995



www.manitowoc.com

Americas
Manitowoc, Wisconsin, USA
Tel: +1 920 684 6621
Fax: +1 920 683 6277

Shady Grove, Pennsylvania, USA
Tel: +1 717 597 8121
Fax: +1 717 597 4062

Europe, Middle East, Africa
Ecully, France
Tel: +33 (0)4 72 18 20 20
Fax: +33 (0)4 72 18 20 00

China
Shanghai, China
Tel: +86 21 6457 0066
Fax: +86 21 6457 4955

Greater Asia-Pacific
Singapore
Tel: +65 6264 1188
Fax: +65 6862 4040

Ref. MC125 - 2012.20 - 0 EN