

GAT 318

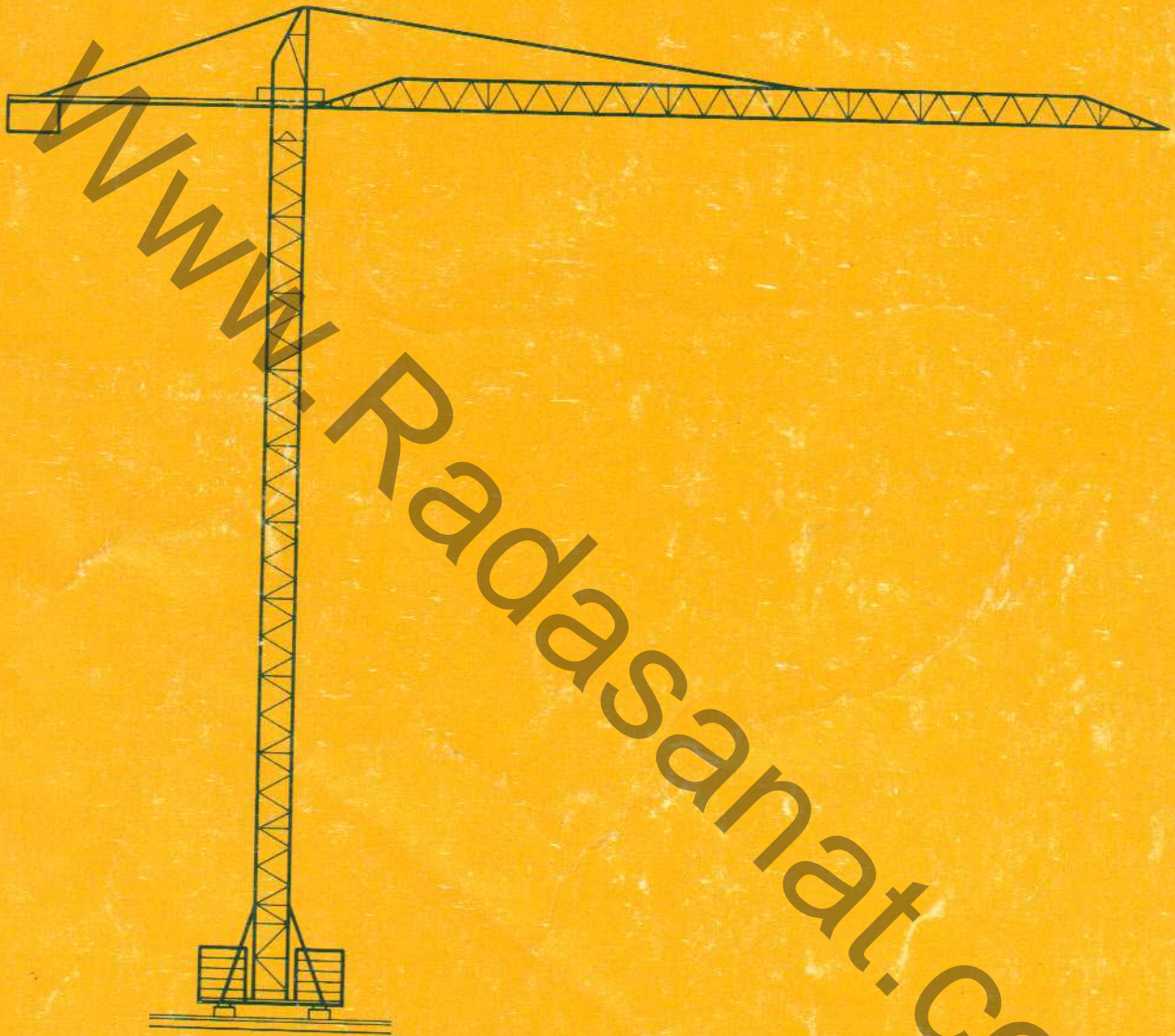

Radasanat.com

(0098)-9121834995

GAT 318

Potain



Courtesy of Crane.Market

Potain GAT 318

Cotes Abmessungen Dimensions Dimensiones

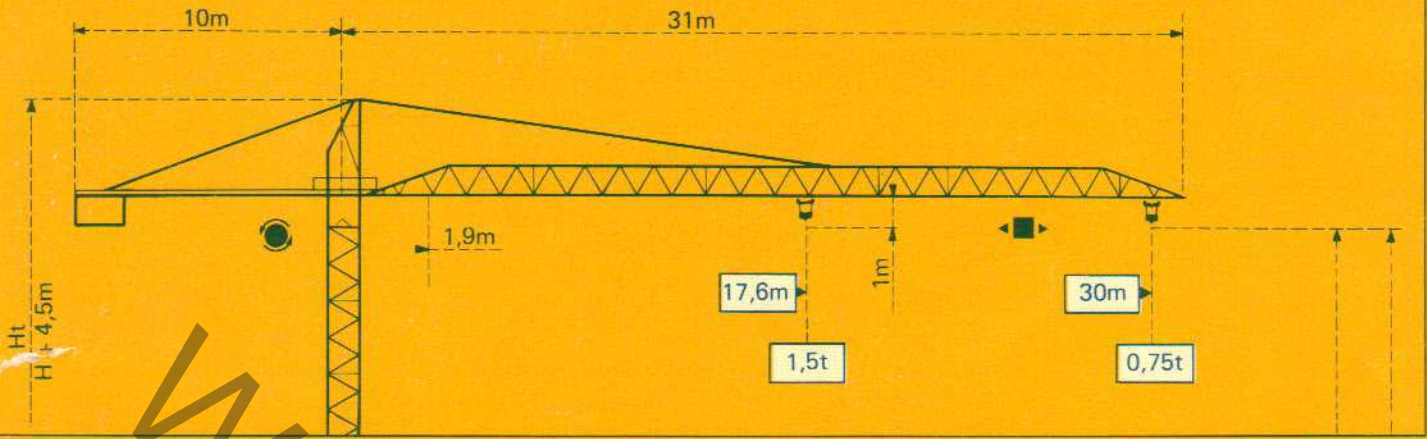

Mature Mast Mast Mástil

∅ 1 m x 1 m

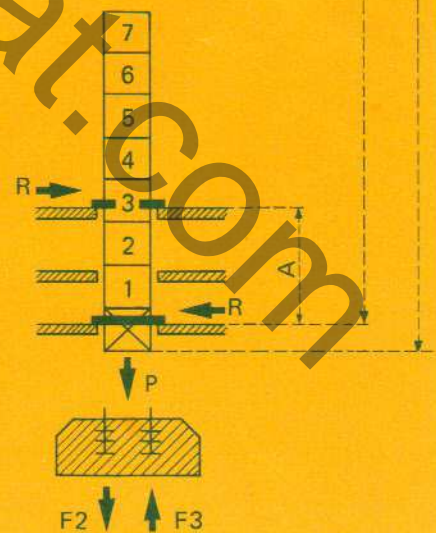
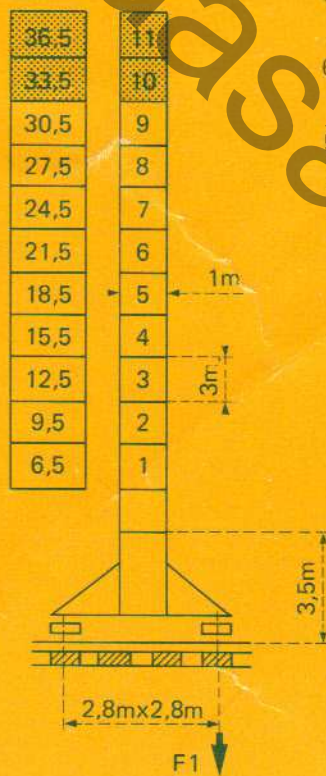
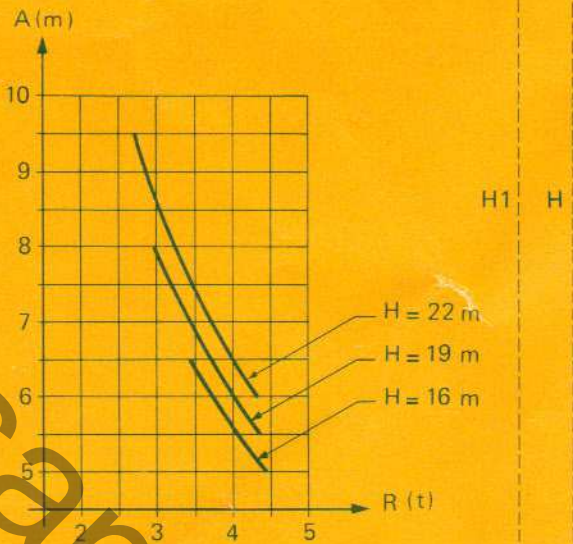

F = Réactions Eckdrücke Reactions Reacciones

F2	● 35 t	■ 50 t
F3	● 28 t	■ 44 t
	9,2 t	

F1	● 24 t	■ 39 t
	11,4 t	

F2	● 35 t
F3	● 28 t
P	● 11,9 t

Courbes de charges Lastkurven Load curves Curvas de cargas



Flèche Ausleger Jib Flecha

1,9	→ 17,6	18	20	22	24	26	28	30	m
30m	1,5	1,45	1,30	1,15	1	0,9	0,8	0,75	t

H = 22 m
 H1 = 21 m
 A mini = 5 m
 A maxi = 9,5 m
 P maxi = 11,9 t



Ancrage au sol hors service
 Verankerung Ausser Betrieb
 Out of Service anchorage
 Anclaje fuera de servicio

Implantations spéciales Einsatzmöglichkeiten
 Special mounting possibilities Instalaciones especiales

Nous consulter
 Auf Anfrage
 Consult us
 Consultarnos

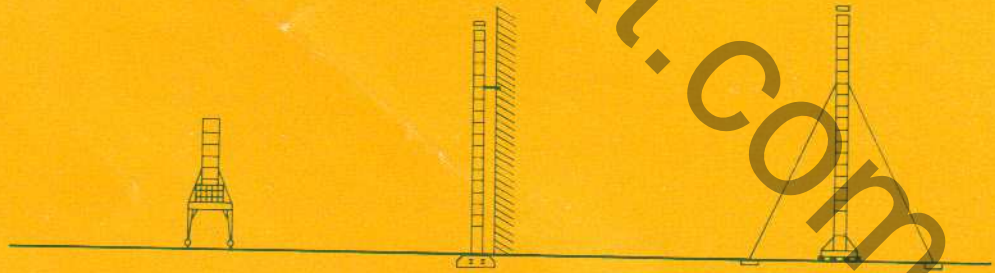

H > H maxi : nous consulter

- En service
- Hors service

A vide sans lest avec flèche et hauteur maximum.

H > H maxi : Auf Anfrage

- In Betrieb
- Ausser Betrieb

Ohne Last und Ballast mit Maximalausleger und Maximalhöhe.

H > H maxi : consult us











- In service
- Out of service

Without load and ballast with longest jib and maximum height.

H > H máxi : Consultarnos

- En servicio
- Fuera de servicio

Sin cargas, sin lastre con flecha y altura máxima.

				m/min	t		ch-PS hp	kW
Levage Heben Hoisting Elevación	8 S 8 			21	1500	124 m ≥ 124 m *	8,2	6
				42	750			
	8 CPC 8 			5,25	1500	182 m ≥ 182 m *		
				21	1500			
				42	750			
Distribution - <i>Katzfahren</i> Trolleying - <i>Distribución</i>		DVT 10		30			1,8	1,32
Orientation - <i>Schwenken</i> Slewing - <i>Orientación</i>		103 MCS 1,6		1,08 tr/min U/min-rpm			3,6	2,6
Translation - <i>Kranfahren</i> Travelling - <i>Traslación</i>		TB 222		30			2 x 3,2	2 x 2,4
Puissance électrique nécessaire Anschlusswert Necessary electric power Potencia eléctrica necesaria	380 V 50 HZ 	Réseau - <i>Netzstrom</i> - Mains supply - <i>Red</i>					40 kVA	
		Groupe électrogène - <i>Stromaggregat</i> Generator set - <i>Grupo electrogeno</i>					*	

* Nous consulter - *Auf Anfrage* - Consult us - *Consultarnos*

Radasanat.com

(0098)-9121834995

 **Potain**

18, rue de Charbonnières B.P 173 - F 69130 ECULLY
Tél. (7) 833.81.81 Téléx 330 179

EXPORT. 89 Av. du Pdt Roosevelt - CHEVILLY - LARUE
F 94150 RUNGIS - Tél. (1) 687.22.23 - Téléx 270001

POTAIN GmbH - D 6082 MÖRFELDEN - WALLDORF
Nordendstr. 79-87 - Postfach 420 - Tel. (6 105) 5091 - Telex 4 185745

POTAIN SUISSE S.A. - CH 5115 MÖRIKEN WILDEGG
Tel. 64.53.19.91 - Telex 68294



modifications réservées - Änderungen vorbehalten - Subject to modification - Modificaciones reservadas
 Ref. 45 GAV
 Printed in France